

Doppel-NPN-Silizium-Fototransistor mit Tageslichtsperrfilter
Dual Silicon NPN Phototransistor with Daylight-Cutoff Filter
Lead (Pb) Free Product - RoHS Compliant

SFH 3162 F

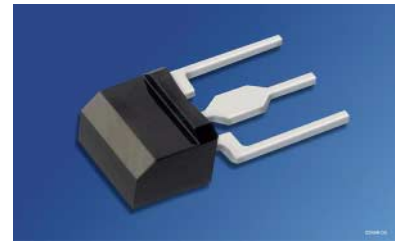

Nicht für Neuentwicklung / Not for new design

Wesentliche Merkmale

- Tageslichtsperrfilter
- Doppel-Fototransistor nebeneinander positioniert
- Doppel-Fototransistor mit gemeinsamem Kollektor
- Optimale Kombination mit SFH4113 (horizontaler Encoder)

Features

- Daylight Filter
- Dual Phototransistor positioned side by side
- Dual Phototransistor with common Collector
- Ideal combination with SFH4113 (horizontal encoder)

Anwendungen

- Richtungserkennung
- Empfänger in Lichtschranken
- Bandende-Erkennung (z.B. Videorecorder)
- Positionsüberwachung
- Barcode-Leser
- „Messen/Steuern/Regeln“
- Münzzähler

Applications

- Direction detection
- Detector in photointerrupters
- Tape end detection
- Position sensing
- Barcode reader
- For control and drive circuits
- Coin counters

Typ Type	Bestellnummer Ordering Code	$I_{ce(on)}$ [μA] ($V_{ce}=3.5V$, $950nm$, $E_e=0.34mW/cm^2$)
SFH 3162 F	Q62702P5297	185 ... 585

Grenzwerte
Maximum Ratings

Bezeichnung Parameter	Symbol Symbol	Wert Value	Einheit Unit
Betriebs- und Lagertemperatur Operating and storage temperature range	$T_{op}; T_{stg}$	- 40 ... + 85	°C
Löttemperatur bei Tauchlötung Lötstelle ≥ 2 mm vom Gehäuse, Lötzeit $t \leq 5$ s Dip soldering temperature ≥ 2 mm distance from case bottom, soldering time $t \leq 5$ s	T_S	260	°C
Löttemperatur bei Kolbenlötung Lötstelle ≥ 2 mm vom Gehäuse, Lötzeit $t \leq 3$ s Iron soldering temperature ≥ 2 mm distance from case bottom, soldering time $t \leq 3$ s	T_S	300	°C
Kollektor-Emitterspannung Collector-emitter voltage	V_{CE}	30	V
Kollektorstrom Collector current	I_C	10	mA
Kollektorspitzenstrom, $t < 10 \mu s$ Collector surge current	I_{CS}	20	mA
Emitter-Kollektorspannung Emitter-collector voltage	V_{EC}	7	V
Verlustleistung, $T_A = 25 \text{ °C}$ Total power dissipation	P_{tot}	100	mW
Wärmewiderstand Sperrschicht - Umgebung Thermal resistance junction - ambient	R_{thJA}	450	K/W

Kennwerte ($T_A = 25\text{ °C}$, $\lambda = 950\text{ nm}$)

Characteristics

Bezeichnung Parameter	Symbol Symbol	Wert Value	Einheit Unit
Wellenlänge der max. Fotoempfindlichkeit Wavelength of max. sensitivity	$\lambda_{S\text{ max}}$	920	nm
Spektraler Bereich der Fotoempfindlichkeit $S = 10\%$ von S_{max} Spectral range of sensitivity $S = 10\%$ of S_{max}	λ	780 ... 1100	nm
Abmessungen der Chip-Fläche Dimension of chip area	$L \times B$ $L \times W$	1.23×0.66	mm \times mm
Bestrahlungsempfindliche Fläche Radiant sensitive area	A	2×0.15	mm ²
Halbwinkel Half angle	φ	± 75	Grad deg.
Kapazität Capacitance $V_{CE} = 3\text{V}$, $f = 1\text{ MHz}$, $E = 0$	C_{CE}	3.2	pF
Dunkelstrom Dark current $V_{CE} = 10\text{ V}$	I_{CEO}	0.1 (≤ 100)	nA
Fotostrom Photocurrent $E_e = 0.34\text{ mW/cm}^2$, $V_{CE} = 3.5\text{ V}$	$I_{e(\text{on})}$ ¹⁾	185 585	μA
Temperaturkoeffizient von $I_{e(\text{on})}$ Temperature coefficient of $I_{e(\text{on})}$ $V_{ce} = 5\text{ V}$	TC	+ 0.9	%/K

¹⁾ $I_{ce(\text{on})}$ ist der Mittelwert der Emitterströme der beiden Fototransistoren.

$I_{ce(\text{on})}$ is the mean value of the emitter currents of the two phototransistors.

Bezeichnung Parameter	Symbol Symbol	Wert Value	Einheit Unit
Emitterstrom-Verhältnis der 2 Fototransistoren Emitter current ratio of the 2 phototransistors $V_{eco} = 3.5V, E_e = 0.34mW/cm^2$	$R^{1)}$	1 ... 1.1	
Übersprechen zwischen T1 und T2 Crosstalk between T1 and T2 $E_e = 0.34 mW/cm^2, \lambda = 950nm, V_{CE} = 3.5 V$	$(I_{e1}-I_{e1'})/I_{e1}^{2)}$	3	%
Anstiegszeit/Abfallzeit Rise and fall time $I_C = 1 mA, V_{CC} = 5 V, R_L = 1 k\Omega$	t_r t_f	11 11	μs
Kollektor-Emitter-Sättigungsspannung Collector-emitter saturation voltage $I_C = 50\mu A,$ $E_e = 0.5 mW/cm^2, \lambda = 950 nm$	V_{CEsat}	0.1 (≤ 0.4)	V

1) $I_{e(max)}/I_{e(min)}$

2) Testing condition

a) I_{e1} measured while the emitter of T2 is grounded

b) $I_{e1'}$ is the I_{e1} reading while the emitter of T2 is not connected

Relative Spectral Sensitivity

$S_{rel} = f(\lambda)$

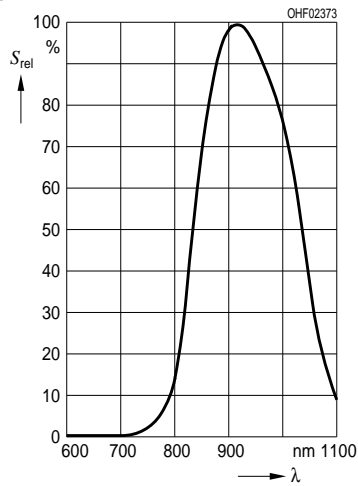

Photocurrent

$I_{PCE} = f(E_e), V_{CE} = 5 V$

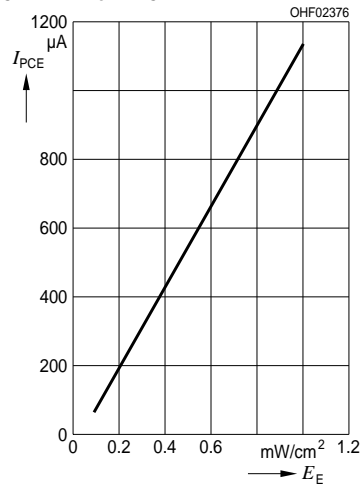

Photocurrent

$I_{PCE} = f(V_{CE})$

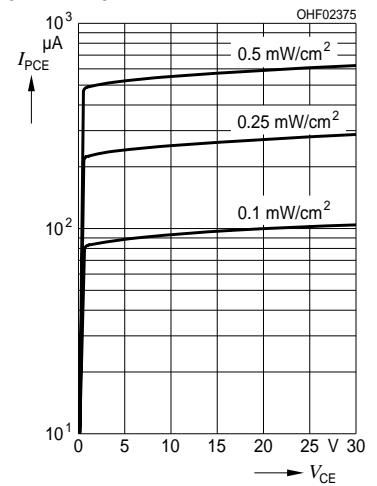

Total Power Dissipation

$P_{tot} = f(T_A)$

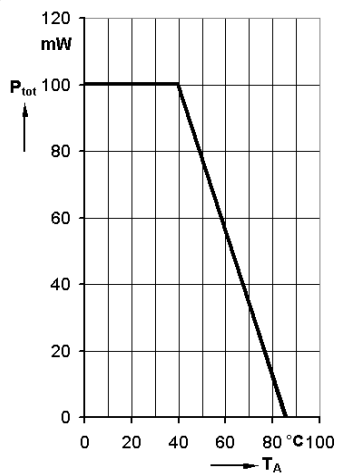

Collector-Emitter Capacitance

$C_{CE} = f(V_{CE}), f = 1 \text{ MHz}, E = 0$

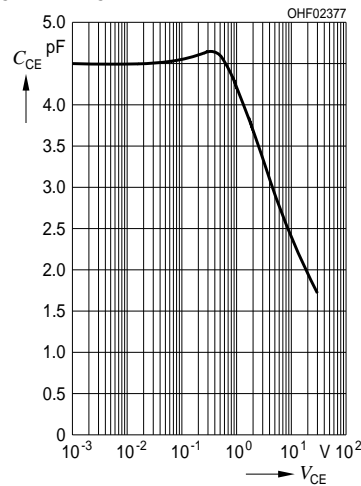

Maßzeichnung Package Outlines

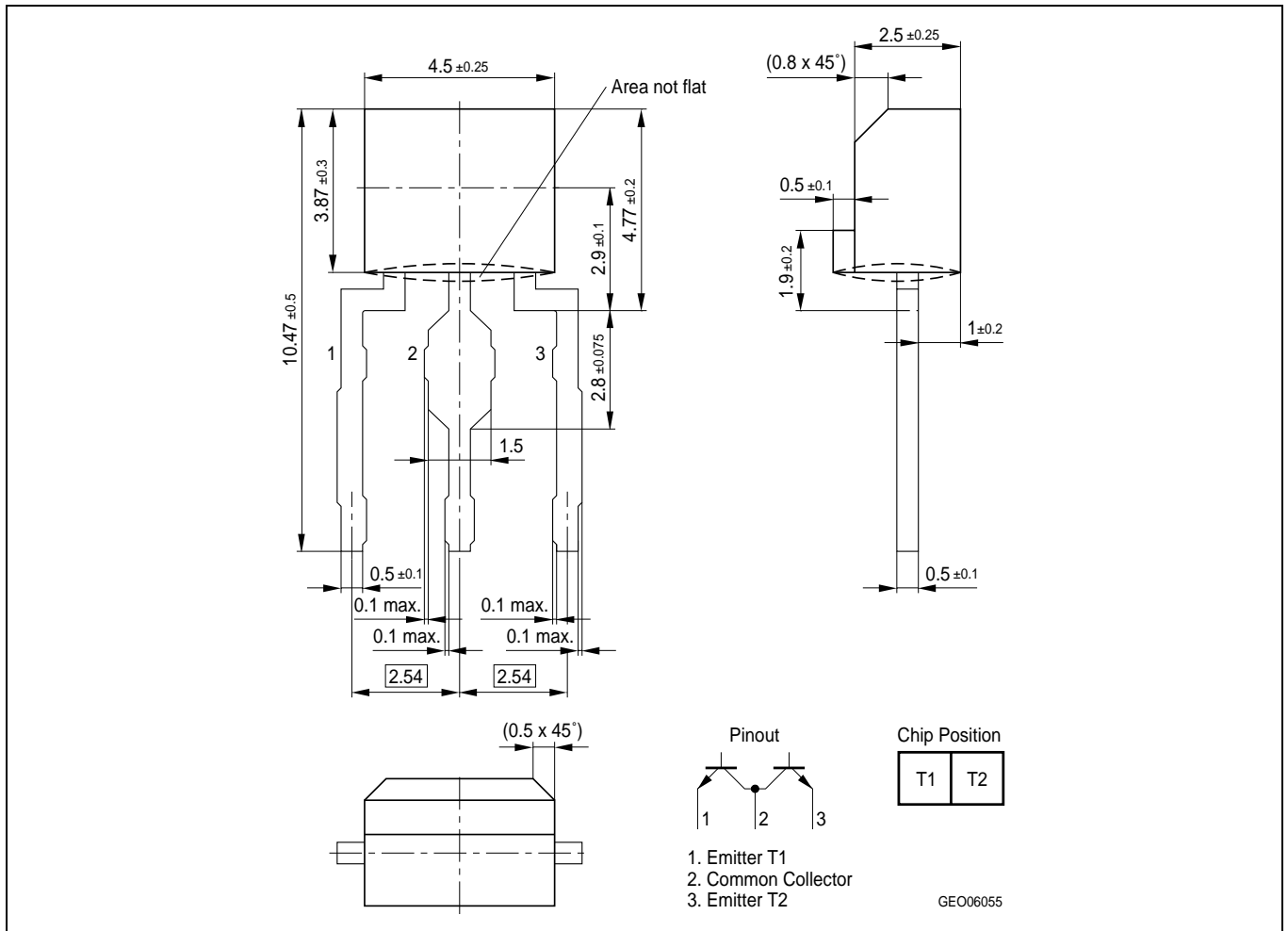

Lötbedingungen
Soldering Conditions
Wellenlöten (TTW)
TTW Soldering

(nach CECC 00802)
(acc. to CECC 00802)

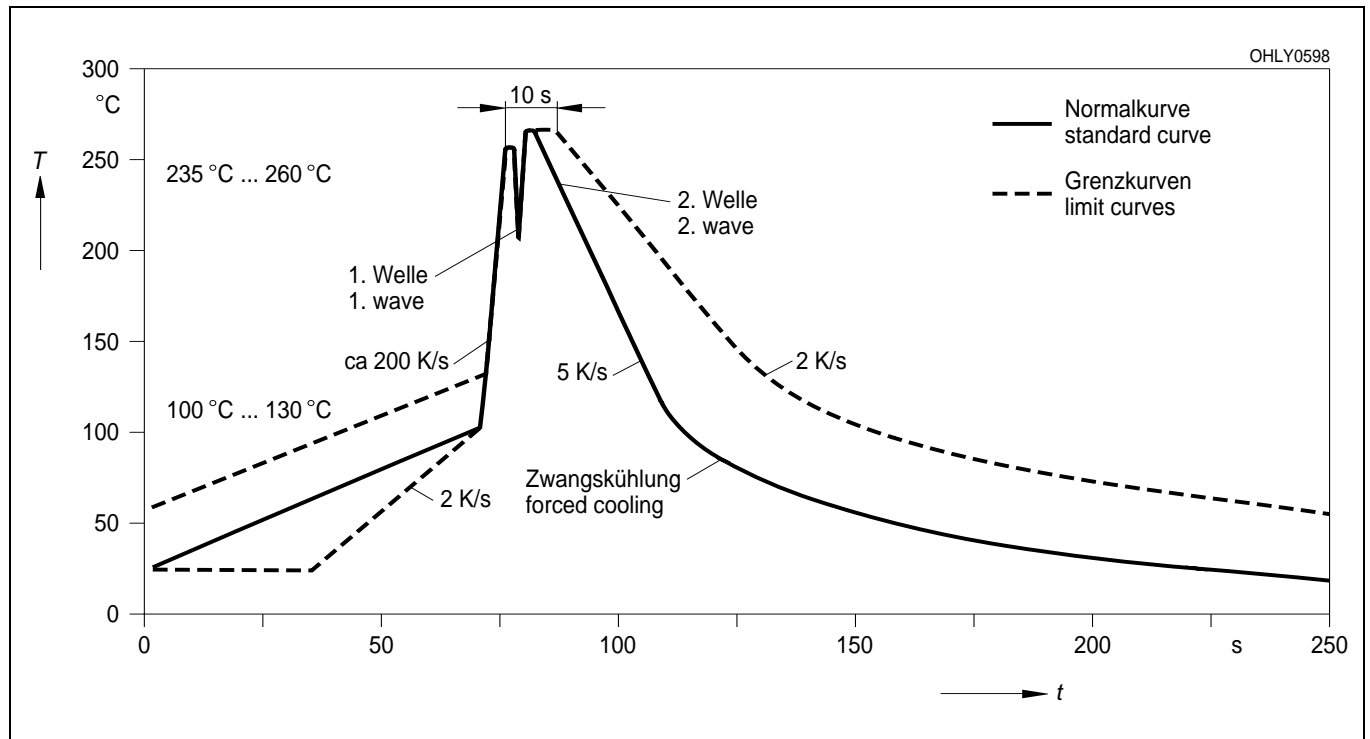

Published by
OSRAM Opto Semiconductors GmbH
Wernerwerkstrasse 2, D-93049 Regensburg
www.osram-os.com

© All Rights Reserved.

The information describes the type of component and shall not be considered as assured characteristics. Terms of delivery and rights to change design reserved. Due to technical requirements components may contain dangerous substances. For information on the types in question please contact our Sales Organization.

Packing

Please use the recycling operators known to you. We can also help you – get in touch with your nearest sales office. By agreement we will take packing material back, if it is sorted. You must bear the costs of transport. For packing material that is returned to us unsorted or which we are not obliged to accept, we shall have to invoice you for any costs incurred.

Components used in life-support devices or systems must be expressly authorized for such purpose! Critical components¹, may only be used in life-support devices or systems² with the express written approval of OSRAM OS.

¹ A critical component is a component used in a life-support device or system whose failure can reasonably be expected to cause the failure of that life-support device or system, or to affect its safety or effectiveness of that device or system.

² Life support devices or systems are intended (a) to be implanted in the human body, or (b) to support and/or maintain and sustain human life. If they fail, it is reasonable to assume that the health of the user may be endangered

EU RoHS and China RoHS compliant product



此产品符合欧盟 RoHS 指令的要求；

按照中国的相关法规和标准，不含有毒有害物质或元素。